

TEM

LOGIO

SWITCH
LOGIQ



TEM

On/Off and everything in between

LOGIQ



Smo proizvajalec stikal in vtičnic, ki svojim uporabnikom zagotavlja pozitivno ter enostavno izkušnjo, hkrati pa s preprosto vgradnjo in uporabo izdelkov, širokim izborom barv in materialov, zadovolji še tako zahtevne želje vsakega uporabnika in prostora.

We are a manufacturer of switches and sockets offering a positive and easy user experience while satisfying the most demanding needs of every user and space with products that are easy to install and use, as well as a wide range of colours and materials.

LOGIQ

LOGIQ

B O L D



LOGIQ

F L A T



LOGIQ

P R I M E



LOGIQ

B O L D



Poudarjena oblika najde mesto v vsakem prostoru.

The distinctive shape has a place in every room.



LOGIQ

B O L D



PW



bela-sijaj

polar white

TI



titan

titanium

AT



antracit

anthracite

BK

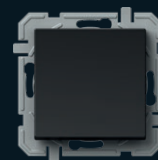

črna

black



PW **bela-sijaj**
polar white



TI **titan**
titanium



AT **antracit**
anthracite



BK **črna**
black

LOGIQ
BOLD





LOGIQ

FLAT

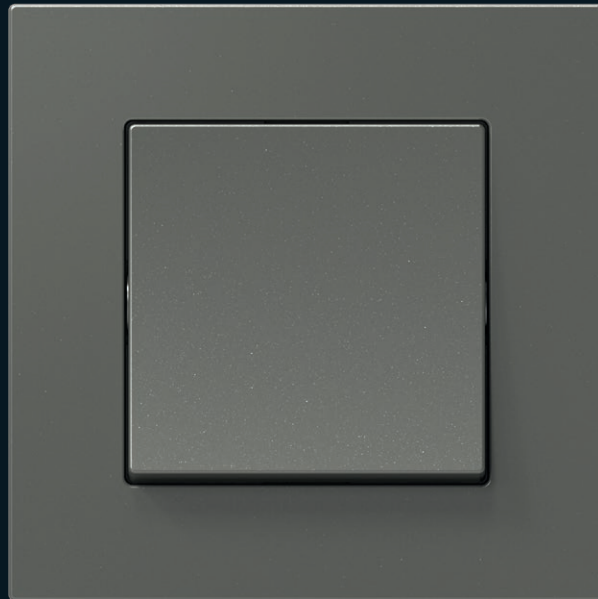

Elegantno, ravno, kvadratno.

Elegant, flat, square.

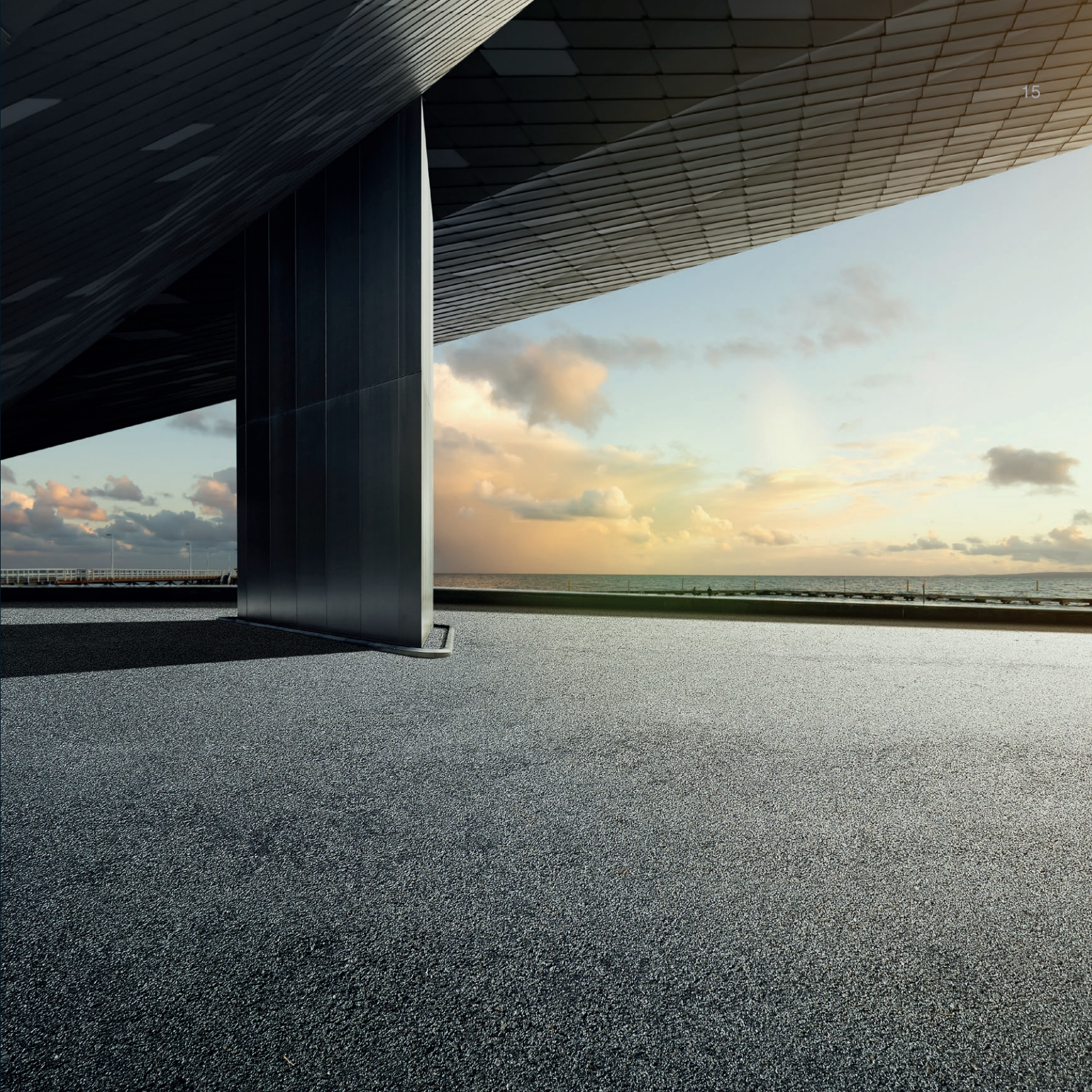

LOGIQ

FLAT



PW



bela-sijaj

polar white

TI



titan

titanium

AT



antracit

anthracite

BK

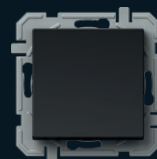

črna

black



PW **bela-sijaj**
polar white



TI **titan**
titanium



AT **antracit**
anthracite



BK **črna**
black

LOGIQ
FLAT





LOGIQ

PRIME



Odsev stekla prebudi petičneža v vas.

The reflection of the glass awakens the magnate in you.



LOGIQ

PRIME



PW



bela-sijaj

polar white

TI



titan

titanium

AT



antracit

anthracite

BK



črna

black

steklo

glass



GL **bela**
glass light



GD **črna**
glass dark

LOGIQ

PRIME





N a r e j e n z a v s a k p r o s t o r

Univerzalne linije stikal pustijo svoj pečat v modernih delovnih okoljih ali v bolj domačih toplih bivalnih prostorih. Za vsako vašo željo vam družina stikal LOGIQ ponuja preprosto in logično rešitev.

M a d e f o r e v e r y r o o m

The switches have universal lines that make a mark in both modern work environments and cosy, comfortable living spaces. The LOGIQ family of switches offers a simple and logical solution for your every wish.



H a r m o n i j a b a r v z a v s a k p r o s t o r

Družino LOGIQ odlikuje logičen izbor preverjenih in elegantnih barvnih odtenkov, ki jih imajo uporabniki najraje. Ne prilagajajte se vi, LOGIQ se prilagaja vam.

H a r m o n y o f c o l o u r s f o r e v e r y r o o m

The LOGIQ family prides itself on its logical range of verified and elegant hues known and loved by our users. Do not compromise, LOGIQ has you covered.

- črna
black
- antracit
anthracite
- titan
titanium
- bela-sijaj
polar white



Neomejena domišljija

Limitless imagination

Družina LOGIQ omogoča sestavljanje poljubnih kombinacij. Za enostavno kombiniranje smo za vas izdelali uporabno dopolnitev, ki olajša nizanje vodoravnih in navpičnih linij. Tako imenovani sistem 55/55 omogoča uporabo enakih univerzalnih elementov.

The LOGIQ family allows you to create your own combinations. To make combining simple, we have created a useful system that supports the sequencing of horizontal and vertical lines. The so-called 55/55 system allows you to use the same universal elements every time.



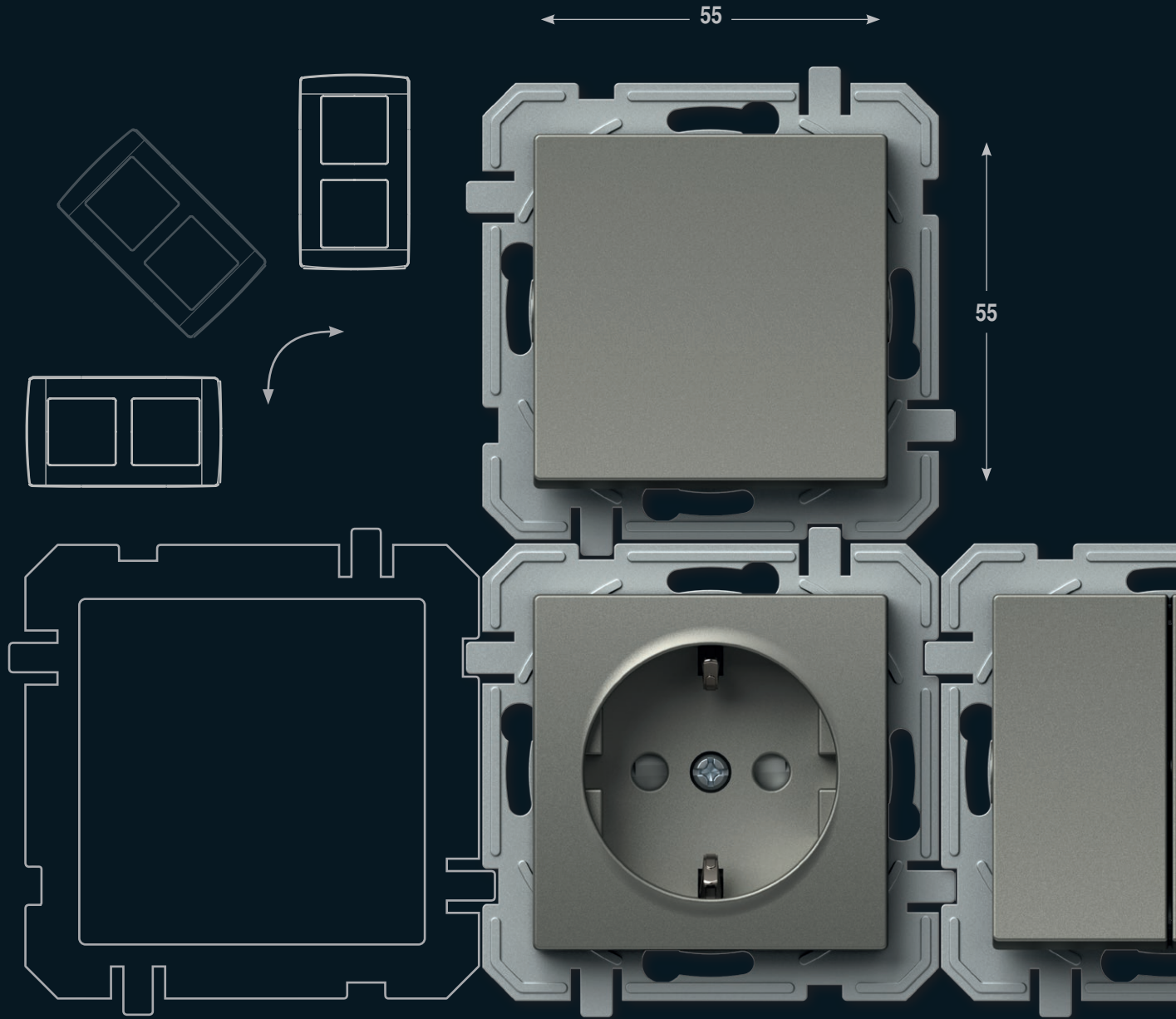

Preprosto za najzahtevnejše

Družina LOGIQ ponuja funkcijske elemente za vsak prostor in namen. Lahko jih uporabite posamično ali v nizu. Vodoravno ali navpično. Logično.



Univerzalna postavitev dekorativnih okvirjev vseh treh oblikovnih linij BOLD, FLAT in PRIME.

A universal layout of decorative cover plates in all three design lines – BOLD, FLAT and PRIME.



Simple for the most demanding

The LOGIQ family offers functional elements for every space and purpose. You can use these products individually or in a sequence, horizontally or vertically. Logically.

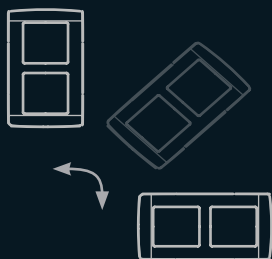

Logična montaža

Logical installation

LOGIQ je rešitev za sistem standardnih okroglih doz. Z njim lahko načrtujete tako enostavne kot tudi zahtevnejše inštalacije, novogradnje in adaptacije. Sistem odlikujejo brezvijačni kontakti, ki vam prihranijo čas pri vgradnji elementov.

LOGIQ is a solution for the system of standardised round installation boxes. It can be used for simple and more demanding installations, new buildings and adaptations. The system is characterised by plug-in contacts that save time during the installation of elements.

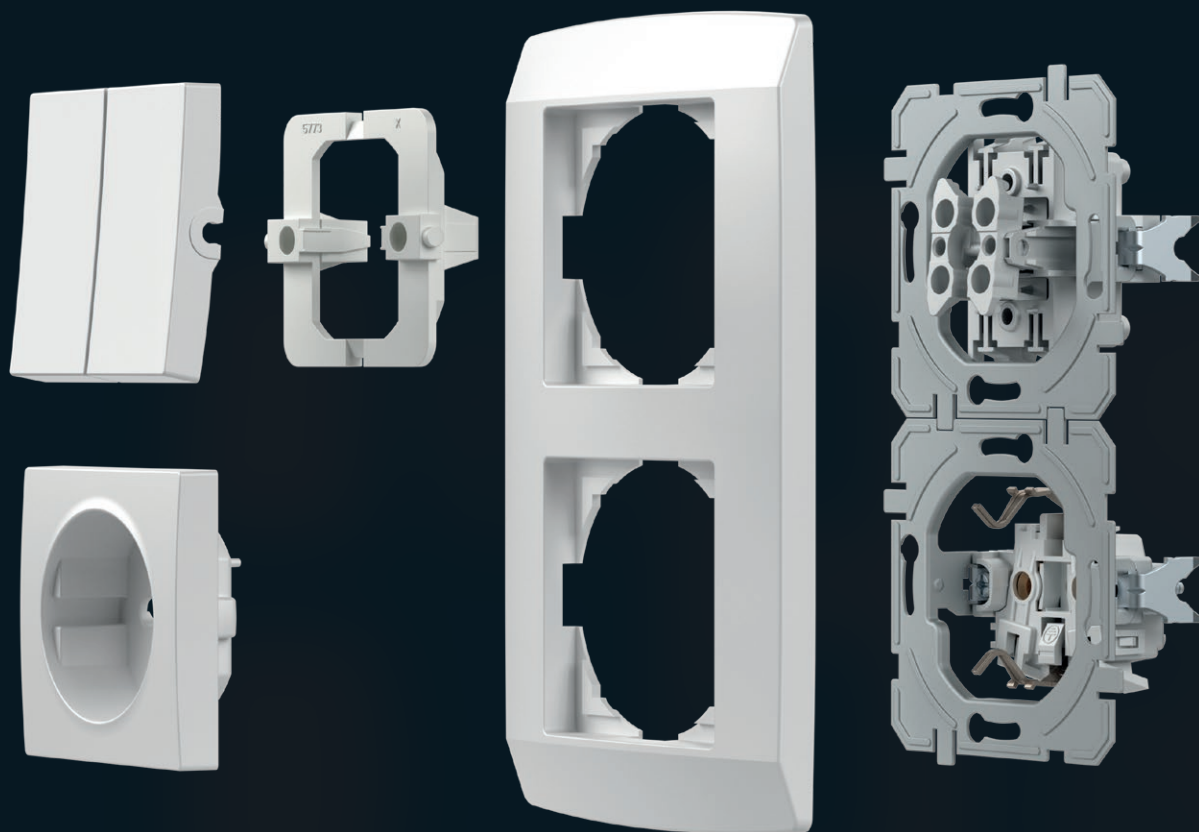

Dobro je vedeti

Good to know



Vse vtičnice imajo vgrajeno varovalo pred dotikom elementov pod napetostjo.

All the sockets are equipped with a safety shutters assuring the protection to live contacts.



Dobro premišljena konstrukcija stikala omogoča enostavno indikacijo tudi naknadno.

The well-thought-out design of the switch enables the easy integration of the indication, including at a later time.



Za zanesljivost preklopa skrbijo kontakti iz srebrne zlitine.

Contacts made of silver alloy guarantee safe switching.

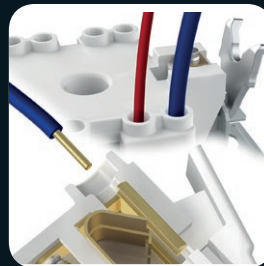

Brezvijačni kontakti omogočajo hitro in zanesljivo priključitev vodnikov. Na isti kontakt lahko pritrdite dva vodnika različnih premerov.

Plug-in contacts enable quick and reliable attachment of wires. Two wires of different diameters can be attached to the same contact.



Krepeljci omogočajo globljo pritrditev (tudi preko keramičnih ploščic ipd.).

Fixing claws enable deeper fixing (also through ceramic tiles, etc.).



Sestavljive doze vam bodo olajšale delo. Prave razdalje so vam zagotovljene.

Easy-fitting installation boxes will make your work easier. Proper lengths are guaranteed.

SQ11 **PW** **IN** **01** **XO**

tip type	naziv description	tehnični opis technical data	barva colour	opcijski opis 1 optional data 1	opcijski opis 2 optional data 2	opcijski opis 3 optional data 3
SQ10	STIKALO ENOPOLNO SWITCH 1WAY	10AX 250V~	<input type="checkbox"/> PW bela - sijaj polar white	NT nevtral neutral	01	XO brez okvirja without cover plate
SQ11	TIPKALO ENOPOLNO PUSH BUTTON 1WAY	10A 250V~	<input type="checkbox"/> TI titan titanium	IN indikator indicator	02	
SQ22	STIKALO DVOPOLNO SWITCH 2POLE	16AX 250V~	<input type="checkbox"/> AT antracit anthracite	I	03	
:	:	:	<input type="checkbox"/> BK črna black			

STIKALO ENOPOLNO 10AX 250V~



- SQ10PWXO
- SQ10TIXO
- SQ10ATXO
- SQ10BKXO



- 10AX 250V~, tip SQ10
 - ustreza EN 60669-1
 - brezvijačna pritrditev vodnikov 1.5-2.5mm²
- SWITCH 1WAY 10AX 250V~*
- 10AX 250V~, type SQ10
 - in accordance with EN 60669-1
 - plug-in contacts 1.5-2.5mm²



STIKALO ENOPOLNO 10AX 250V~ __ IN



- SQ10PWIXO
- SQ10TIIXO
- SQ10ATIXO
- SQ10BKIXO

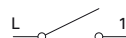

- IN indikator, brez tlivke
 - 10AX 250V~, tip SQ10
 - ustreza EN 60669-1
 - brezvijačna pritrditev vodnikov 1.5-2.5mm²
- SWITCH 1WAY 10AX 250V~ __ IN*
- IN indicator, without neon lamp
 - 10AX 250V~, type SQ10
 - in accordance with EN 60669-1
 - plug-in contacts 1.5-2.5mm²





- SQ11PWXO
- SQ11TIXO
- SQ11ATXO
- SQ11BKXO

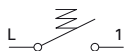

TIPKALO ENOPOLNO 10A 250V~

- 10A 250V~, tip SQ11
- ustreza EN 60669-1
- brezvijačna pritrditev vodnikov 1.5-2.5mm²

PUSH BUTTON 1WAY 10A 250V~

- 10A 250V~, type SQ11
- in accordance with EN 60669-1
- plug-in contacts 1.5-2.5mm²



- SQ11PWIN01XO
- SQ11TIIN01XO
- SQ11ATIN01XO
- SQ11BKIN01XO

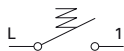

TIPKALO ENOPOLNO 10A 250V~ __ IN 01

- IN 01 indikator zvonec, brez tlivke
- 10A 250V~, tip SQ11
- ustreza EN 60669-1
- brezvijačna pritrditev vodnikov 1.5-2.5mm²

PUSH BUTTON 1WAY 10A 250V~ __ IN 01

- IN 01 indicator bell, without neon lamp
- 10A 250V~, type SQ11
- in accordance with EN 60669-1
- plug-in contacts 1.5-2.5mm²



- SQ11PWIN02XO
- SQ11TIIN02XO
- SQ11ATIN02XO
- SQ11BKIN02XO

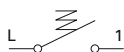

TIPKALO ENOPOLNO 10A 250V~ __ IN 02

- IN 02 indikator luč, brez tlivke
- 10A 250V~, tip SQ11
- ustreza EN 60669-1
- brezvijačna pritrditev vodnikov 1.5-2.5mm²

PUSH BUTTON 1WAY 10A 250V~ __ IN 02

- IN 02 indicator light, without neon lamp
- 10A 250V~, type SQ11
- in accordance with EN 60669-1
- plug-in contacts 1.5-2.5mm²



- SQ22PWIN03XO
- SQ22TIIN03XO
- SQ22ATIN03XO
- SQ22BKIN03XO

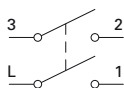

STIKALO DVOPOLNO 16AX 250V~ __ IN 03

- IN 03 nevtral 0-1, brez tlivke
- 16AX 250V~, tip SQ22
- ustreza EN 60669-1
- vijajna pritrditev vodnikov 1.5-2.5mm²

SWITCH 2POLE 16AX 250V~ __ IN 03

- IN 03 neutral 0-1, without neon lamp
- 16AX 250V~, type SQ22
- in accordance with EN 60669-1
- screw contacts 1.5-2.5mm²



- SQ50PWXO
- SQ50TIXO
- SQ50ATXO
- SQ50BKXO

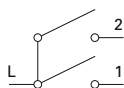

STIKALO SERIJSKO 10AX 250V~

- 10AX 250V~, tip SQ50
- ustreza EN 60669-1
- brezvijačna pritrditev vodnikov 1.5-2.5mm²

SWITCH 2GANG-1WAY 10AX 250V~

- 10AX 250V~, type SQ50
- in accordance with EN 60669-1
- plug-in contacts 1.5-2.5mm²



TIPKALO SERIJSKO 10A 250V~



- SQ51PWXO
- SQ51TIXO
- SQ51ATXO
- SQ51BKXO

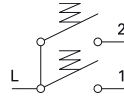

- 10A 250V~, tip SQ51
- ustreza EN 60669-1
- brezvijačna pritrditev vodnikov 1.5-2.5mm²

PUSH BUTTON 2GANG-1WAY 10A 250V~

- 10A 250V~, type SQ51
- in accordance with EN 60669-1
- plug-in contacts 1.5-2.5mm²



STIKALO ŽALUZIJSKO 10AX 250V~ __ NT 09



- SQ52PWNT09XO
- SQ52TINT09XO
- SQ52ATNT09XO
- SQ52BKNT09XO

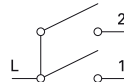

- NT 09 nevtral gor-dol
- 10AX 250V~, tip SQ52
- ustreza EN 60669-1
- brezvijačna pritrditev vodnikov 1.5-2.5mm²
- z mehansko blokado hkratnega vklopa

SWITCH SHUTTERS 10AX 250V~ __ NT 09

- NT 09 neutral up-down
- 10AX 250V~, type SQ52
- in accordance with EN 60669-1
- plug-in contacts 1.5-2.5mm²
- with mechanical interblock



TIPKALO ŽALUZIJSKO 10A 250V~ __ NT 09



- SQ53PWNT09XO
- SQ53TINT09XO
- SQ53ATNT09XO
- SQ53BKNT09XO

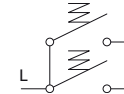

- NT 09 nevtral gor-dol
- 10A 250V~, tip SQ53
- ustreza EN 60669-1
- brezvijačna pritrditev vodnikov 1.5-2.5mm²
- z mehansko blokado hkratnega vklopa

PUSH BUTTON SHUTTERS 10A 250V~ __ NT 09

- NT 09 neutral up-down
- 10A 250V~, type SQ53
- in accordance with EN 60669-1
- plug-in contacts 1.5-2.5mm²
- with mechanical interblock



STIKALO MENJALNO 10AX 250V~



- SQ60PWXO
- SQ60TIXO
- SQ60ATXO
- SQ60BKXO

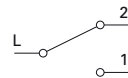

- 10AX 250V~, tip SQ60
- ustreza EN 60669-1
- brezvijačna pritrditev vodnikov 1.5-2.5mm²

SWITCH 2WAY 10AX 250V~

- 10AX 250V~, type SQ60
- in accordance with EN 60669-1
- plug-in contacts 1.5-2.5mm²



STIKALO DVOJNO MENJALNO 10AX 250V~



- SQ63PWXO
- SQ63TIXO
- SQ63ATXO
- SQ63BKXO

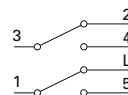

- 10AX 250V~, tip SQ63
- ustreza EN 60669-1
- brezvijačna pritrditev vodnikov 1.5-2.5mm²

SWITCH DOUBLE 2WAY 10AX 250V~

- 10AX 250V~, type SQ63
- in accordance with EN 60669-1
- plug-in contacts 1.5-2.5mm²





- SQ70PWXO
- SQ70TIXO
- SQ70ATXO
- SQ70BKXO



STIKALO KRIŽNO 10AX 250V~

- 10AX 250V~, tip SQ70
- ustreza EN 60669-1
- brezvijačna pritrditev vodnikov 1.5-2.5mm²

SWITCH INTERMEDIATE 10AX 250V~

- 10AX 250V~, type SQ70
- in accordance with EN 60669-1
- plug-in contacts 1.5-2.5mm²



SQ10
SQ11

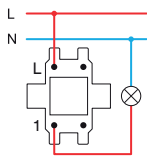

SQ22

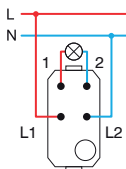

SQ50
SQ51

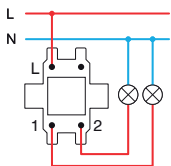

SQ52
SQ53

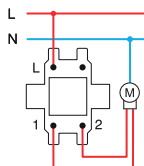

SQ60+SQ60

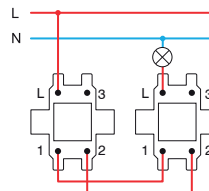

SQ63+SQ63

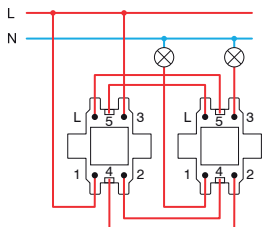

SQ60+SQ70+SQ60

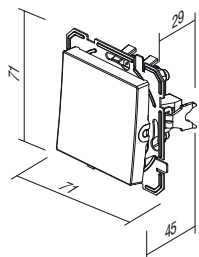
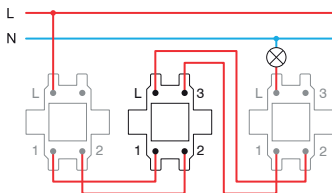

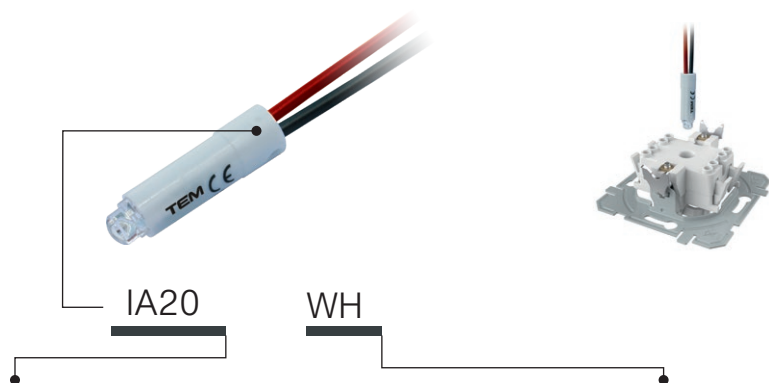

tip type	naziv description	tehnični opis technical data	barva colour
IA10	TLIVKA NEON LAMP	230V~ 0,34W	<input type="checkbox"/> WH bela white
IA20	LED SIGNALIZACIJA LED SIGNALLING UNIT	230V~ 0,40W	<input checked="" type="checkbox"/> BL modra blue
IA21	LED SIGNALIZACIJA LED SIGNALLING UNIT	24V AC/DC 0,20W	<input checked="" type="checkbox"/> RD rdeča red
.	.	.	<input checked="" type="checkbox"/> GR zelena green
.	.	.	<input checked="" type="checkbox"/> OR oranžna orange

TLIVKA 230V~ 0,34W

IA10OR

- za indikacijo, osvetlitev ali stalno osvetlitev stikala
- v kombinaciji s tipko z indikatorjem

NEON LAMP 230V~ 0,34W

- for indication, illumination or constant illumination of switch
- in combination with button with indicator

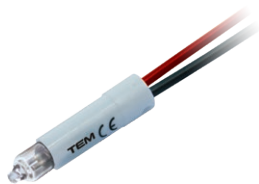

LED SIGNALIZACIJA 230V AC/DC 0,40W

IA20WH
 IA20GR
 IA20RD
 IA20BL

- za indikacijo, signalizacijo ali stalno signalizacijo stikala
- v kombinaciji s tipko z indikatorjem

LED SIGNALLING UNIT 230V AC/DC 0,40W

- for indication, signalling or permanent signalling
- in combination with a button featuring an indicator

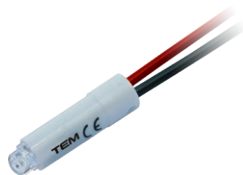

LED SIGNALIZACIJA 24V AC/DC 0,20W

IA21WH
 IA21RD

- za indikacijo, signalizacijo ali stalno signalizacijo stikala
- v kombinaciji s tipko z indikatorjem

LED SIGNALLING UNIT 24V AC/DC 0,20W

- for indication, signalling or permanent signalling
- in combination with a button featuring an indicator

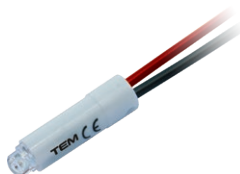

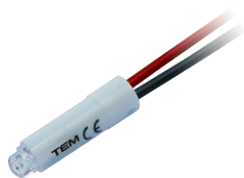

- IA22WH
- IA22RD

LED SIGNALIZACIJA 12V AC/DC 0,10W

- za indikacijo, signalizacijo
- ali stalno signalizacijo stikala
- v kombinaciji s tipko z indikatorjem

LED SIGNALLING UNIT 12V AC/DC 0,10W

- for indication, signalling
- or permanent signalling
- in combination with a button featuring an indicator

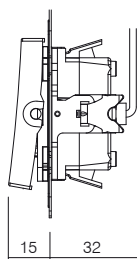

S I G N A L I Z A C I J A I A

* Indikacija /
Indication

Signalizacija /
Signalization

* Stalna signalizacija /
Permanent signalling

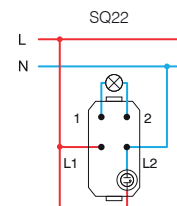
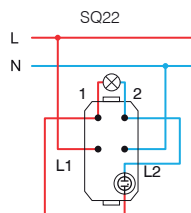
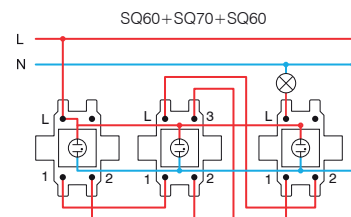
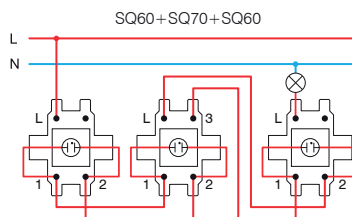
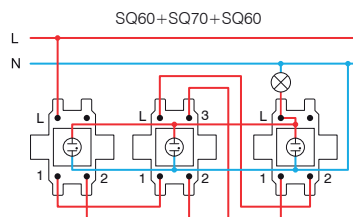
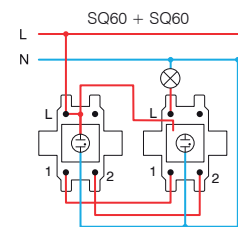
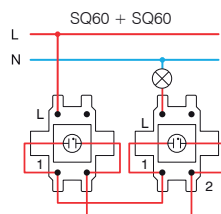
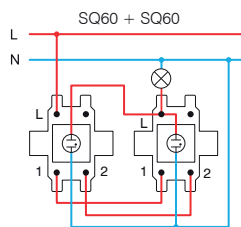
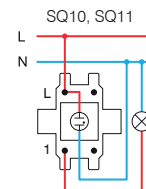
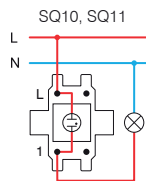
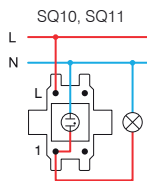

* vezave primerne za varčne (CFL, LED) sijalke /
wiring scheme for energy saving lamps (CFL, LED)

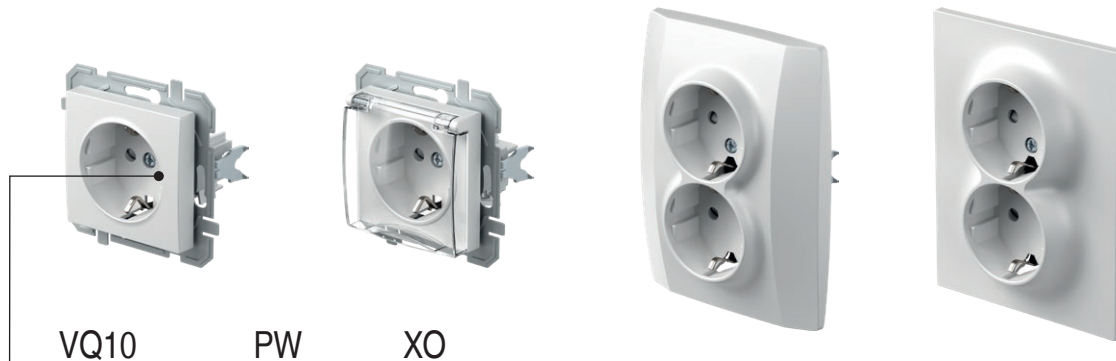

tip <i>type</i>	naziv <i>description</i>	tehnični opis <i>technical data</i>	opcijski opis 1 <i>optional data 1</i>
VQ10	VTIČNICA SCHUKO SOCKET SCHUKO	2P+E 16A 250V~	XO brez okvirja without cover plate
VQ11	VTIČNICA SCHUKO+POKROV SOCKET SCHUKO+COVER	2P+E 16A 250V~	
VQ12	VTIČNICA SCHUKO SOCKET SCHUKO	2P+E 16A 250V~ BV	
:	:	:	
:	:	:	

barva
colour

<input type="checkbox"/> PW	bela - sijaj <i>polar white</i>	<input type="checkbox"/> PT	bela+prozorna <i>white+transparent</i>	<input type="checkbox"/> PP	bela+bela <i>white+white</i>
<input type="checkbox"/> TI	titan <i>titanium</i>	<input type="checkbox"/> TT	titan+prozorna <i>titanium+transparent</i>	<input type="checkbox"/> TI	titan+titan <i>titanium+titanium</i>
<input type="checkbox"/> AT	antracit <i>anthracite</i>	<input type="checkbox"/> AT	antracit+prozorna <i>anthracite+transparent</i>	<input type="checkbox"/> AA	antracit+antracit <i>anthracite+anthracite</i>
<input type="checkbox"/> BK	črna <i>black</i>	<input type="checkbox"/> BT	črna+prozorna <i>black+transparent</i>	<input type="checkbox"/> BB	črna+črna <i>black+black</i>
<input type="checkbox"/> RD	rdeča <i>red</i>	<input type="checkbox"/> RT	rdeča+prozorna <i>red+transparent</i>	<input type="checkbox"/> RR	rdeča+rdeča <i>red+red</i>
<input type="checkbox"/> GR	zelena <i>green</i>	<input type="checkbox"/> GT	zelena+prozorna <i>green+transparent</i>	<input type="checkbox"/> GG	zelena+zelena <i>green+green</i>
<input type="checkbox"/> OR	oranžna <i>orange</i>	<input type="checkbox"/> OT	oranžna+prozorna <i>orange+transparent</i>	<input type="checkbox"/> OO	oranžna+oranžna <i>orange+orange</i>



schuko - ustreza EN 60884-1, CEE7 (list III)

schuko - in accordance with EN 60884-1, CEE7 (standard sheet III)

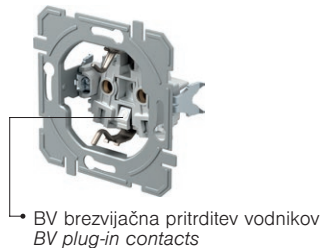
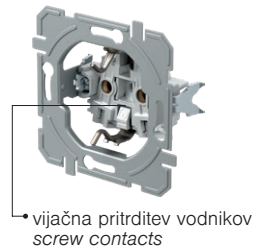

- VQ10PWXO
- VQ10TIXO
- VQ10ATXO
- VQ10BKXO

- VQ10RDXO
- VQ10GRXO
- VQ10ORXO

VTIČNICA SCHUKO 2P+E 16A 250V~ __ XO

- vijačna pritrditvev vodnikov 1.5-2.5mm²
- XO brez okvirja
- 2P+E schuko
- 16A 250V~, tip VQ10
- vgrajena zaščita pred dotikom kontaktov

SOCKET SCHUKO 2P+E 16A 250V~ __ XO

- screw contacts 1.5-2.5mm²
- XO without surround
- 2P+E schuko
- 16A 250V~, type VQ10
- shuttered live contacts

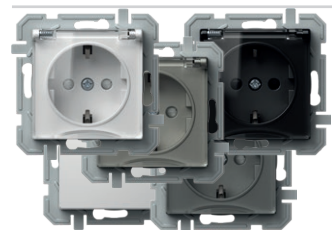

- VQ11PTXO
- VQ11TTXO
- VQ11ATXO
- VQ11BTXO

- VQ11PPXO
- VQ11TIXO
- VQ11AAXO
- VQ11BBXO

VTIČNICA SCHUKO+POKROV 2P+E 16A 250V~ __ XO

- vijačna pritrditvev vodnikov 1.5-2.5mm²
- XO brez okvirja
- 2P+E schuko+pokrov
- 16A 250V~, tip VQ11
- vgrajena zaščita pred dotikom kontaktov

SOCKET SCHUKO+COVER 2P+E 16A 250V~ __ XO

- screw contacts 1.5-2.5mm²
- XO without surround
- 2P+E schuko+cover
- 16A 250V~, type VQ11
- shuttered live contacts



- VQ12PWXO
- VQ12TIXO
- VQ12ATXO
- VQ12BKXO

- VQ12RDXO
- VQ12GRXO
- VQ12ORXO

VTIČNICA SCHUKO 2P+E 16A 250V~ BV __ XO

- BV brezvijačna pritrditvev vodnikov 1.5-2.5mm²
- XO brez okvirja
- 2P+E schuko
- 16A 250V~, tip VQ12
- vgrajena zaščita pred dotikom kontaktov

SOCKET SCHUKO 2P+E 16A 250V~ BV __ XO

- BV plug-in contacts 1.5-2.5mm²
- XO without surround
- 2P+E schuko
- 16A 250V~, type VQ12
- shuttered live contacts





- VQ13PTXO
- VQ13TTXO
- VQ13ATXO
- VQ13BTXO

- VQ13PPXO
- VQ13TIXO
- VQ13AAXO
- VQ13BBXO

VTIČNICA SCHUKO+POKROV 2P+E 16A 250V~ BV __ XO

- BV brezvijačna pritrditev vodnikov 1.5-2.5mm²
- XO brez okvirja
- 2P+E schuko+pokrov
- 16A 250V~, tip VQ13
- vgrajena zaščita pred dotikom kontaktov

SOCKET SCHUKO+COVER 2P+E 16A 250V~ BV __ XO

- BV plug-in contacts 1.5-2.5mm²
- XO without surround
- 2P+E schuko+cover
- 16A 250V~, type VQ13
- shuttered live contacts



- VQ16PW
- VQ16TI
- VQ16AT
- VQ16BK

VTIČNICA SCHUKO DVOJNA 2P+E 16A 250V~

- 2P+E schuko dvojna
- 16A 250V~, tip VQ16
- ustreza IEC 60884-1, CEE7
- vijačna pritrditev vodnikov 1.5-2.5 mm²
- vgrajena zaščita pred dotikom kontaktov

SOCKET SCHUKO DOUBLE 2P+E 16A 250V~

- 2P+E schuko double
- 16A 250V~, type VQ16
- in accordance with IEC 60884-1, CEE7
- screw contacts 1.5-2.5 mm²
- shuttered live contacts



- VQ16PW
- VQ16TIF
- VQ16ATF
- VQ16BKF

VTIČNICA SCHUKO DVOJNA 2P+E 16A 250V~

- 2P+E schuko dvojna
- 16A 250V~, tip VQ16
- ustreza IEC 60884-1, CEE7
- vijačna pritrditev vodnikov 1.5-2.5 mm²
- vgrajena zaščita pred dotikom kontaktov

SOCKET SCHUKO DOUBLE 2P+E 16A 250V~

- 2P+E schuko double
- 16A 250V~, type VQ16
- in accordance with IEC 60884-1, CEE7
- screw contacts 1.5-2.5 mm²
- shuttered live contacts

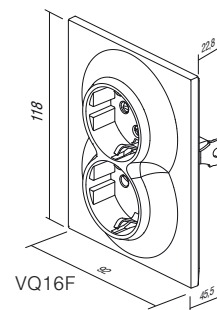
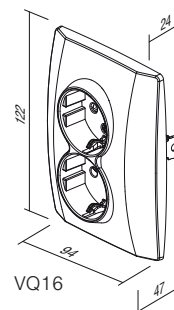
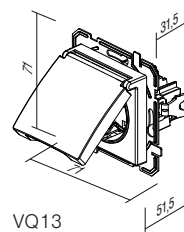
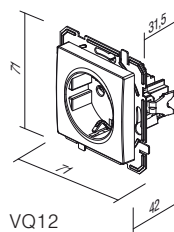
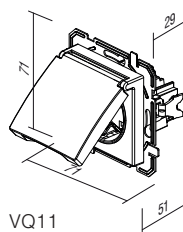
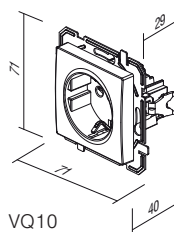

VTIČNICA FRANCOSKA 2P+E 16A 250V~ __ XO

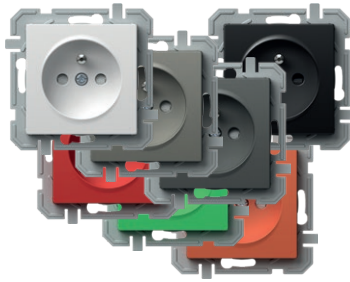

- VQ40PWXO
- VQ40TIXO
- VQ40ATXO
- VQ40BKXO

- VQ40RDXO
- VQ40GRXO
- VQ40ORXO

- vijajna pritrditev vodnikov 1.5-2.5mm²
- XO brez okvirja
- 2P+E francoska
- 16A 250V~, tip VQ40
- vgrajena zaščita pred dotikom kontaktov



SOCKET FRENCH 2P+E 16A 250V~ __ XO

- screw contacts 1.5-2.5mm²
- XO without surround
- 2P+E French
- 16A 250V~, type VQ40
- shuttered live contacts

VTIČNICA FRANCOSKA+POKROV 2P+E 16A 250V~ __ XO



- VQ41PTXO
- VQ41TTXO
- VQ41ATXO
- VQ41BKXO

- VQ41PPXO
- VQ41TIXO
- VQ41AAXO
- VQ41BBXO

- vijajna pritrditev vodnikov 1.5-2.5mm²
- XO brez okvirja
- 2P+E francoska+pokrov
- 16A 250V~, tip VQ41
- vgrajena zaščita pred dotikom kontaktov



SOCKET FRENCH+COVER 2P+E 16A 250V~ __ XO

- screw contacts 1.5-2.5mm²
- XO without surround
- 2P+E French+cover
- 16A 250V~, type VQ41
- shuttered live contacts

VTIČNICA FRANCOSKA 2P+E 16A 250V~ BV __ XO

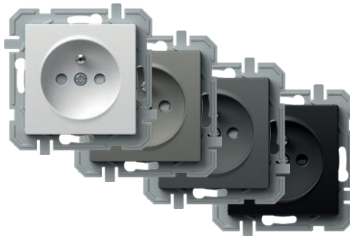

- VQ42PWXO
- VQ42TIXO
- VQ42ATXO
- VQ42BKXO

- BV brezvijajna pritrditev vodnikov 1.5-2.5mm²
- XO brez okvirja
- 2P+E francoska
- 16A 250V~, tip VQ42
- vgrajena zaščita pred dotikom kontaktov



SOCKET FRENCH 2P+E 16A 250V~ BV __ XO

- BV plug-in contacts 1.5-2.5mm²
- XO without surround
- 2P+E French
- 16A 250V~, type VQ42
- shuttered live contacts

VTIČNICA FRANCOSKA+POKROV 2P+E 16A 250V~ BV __ XO



- VQ43PTXO
- VQ43TTXO
- VQ43ATXO
- VQ43BKXO

- VQ43PPXO
- VQ43TIXO
- VQ43AAXO
- VQ43BBXO

- BV brezvijajna pritrditev vodnikov 1.5-2.5mm²
- XO brez okvirja
- 2P+E francoska+pokrov
- 16A 250V~, tip VQ43
- vgrajena zaščita pred dotikom kontaktov



SOCKET FRENCH+COVER 2P+E 16A 250V~ BV __ XO

- BV plug-in contacts 1.5-2.5mm²
- XO without surround
- 2P+E French+cover
- 16A 250V~, type VQ43
- shuttered live contacts



- VQ46PW
- VQ46TI
- VQ46AT
- VQ46BK

VTIČNICA FRANCOSKA DVOJNA 2P+E 16A 250V~

- 2P+E francoska dvojna
- 16A 250V~, tip VQ46
- ustreza IEC 60884-1, CEE7; NF C 61-314, CSN 33 2318; PN-E 93201
- vijajčna pritrditev vodnikov 1,5-2,5 mm²
- vgrajena zaščita pred dotikom kontaktov

SOCKET FRENCH DOUBLE 2P+E 16A 250V~

- 2P+E French double
- 16A 250V~, type VQ46
- in accordance with IEC 60884-1, CEE7; NF C 61-314, CSN 33 2318; PN-E 93201
- screw contacts 1,5-2,5 mm²
- shuttered live contacts



- VQ46PWF
- VQ46TIF
- VQ46ATF
- VQ46BKF

VTIČNICA FRANCOSKA DVOJNA 2P+E 16A 250V~

- 2P+E francoska dvojna
- 16A 250V~, tip VQ46
- ustreza IEC 60884-1, CEE7; NF C 61-314, CSN 33 2318; PN-E 93201
- vijajčna pritrditev vodnikov 1,5-2,5 mm²
- vgrajena zaščita pred dotikom kontaktov

SOCKET FRENCH DOUBLE 2P+E 16A 250V~

- 2P+E French double
- 16A 250V~, type VQ46
- in accordance with IEC 60884-1, CEE7; NF C 61-314, CSN 33 2318; PN-E 93201
- screw contacts 1,5-2,5 mm²
- shuttered live contacts

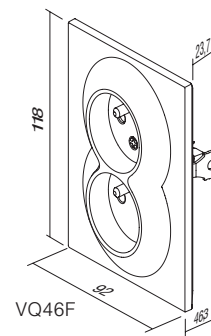
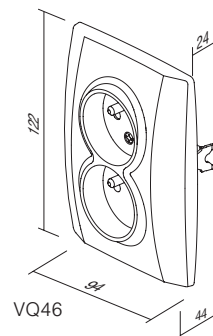
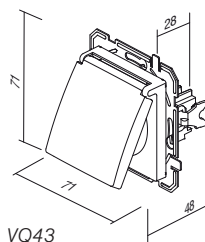
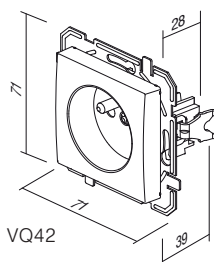
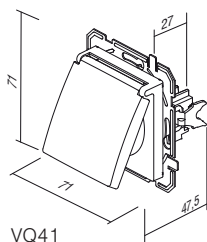
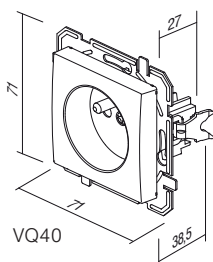



tip type	naziv description	tehnični opis technical data	barva colour	opsijski opis 1 optional data 1
KQ11	VTIČNICA TV-R KONČNA SOCKET TV-R END-LINE	1dB	<input type="checkbox"/> PW bela - sijaj polar white	XO brez okvirja without cover plate
KQ12	VTIČNICA TV-R PREHODNA SOCKET TV-R THROUGHPASS	10dB	<input type="checkbox"/> TI titan titanium	
KQ16	VTIČNICA SAT-TV-R KONČNA SOCKET SAT-TV-R END-LINE	3dB	<input type="checkbox"/> AT antracit anthracite	
.	.	.	<input type="checkbox"/> BK črna black	
.	.	.		



- KQ10PWXO
- KQ10TIXO
- KQ10ATXO
- KQ10BKXO

VTIČNICA TV OSNOVNA 0dB

- TV osnovna
- dušenje 0dB
- konektor zadaj – F standard

SOCKET TV BASIC 0dB

- TV basic
- reduction 0dB
- back connector – F standard



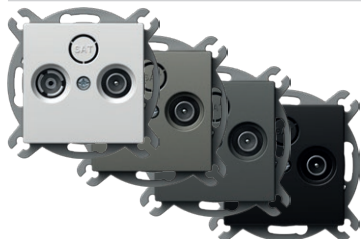

- KQ11PWXO
- KQ11TIXO
- KQ11ATXO
- KQ11BKXO

VTIČNICA TV-R KONČNA 1dB

- TV-R končna
- frekvenčni pas 5÷862 MHz
- dušenje: R-1,5dB, TV-1dB
- ustreza EN 50083-1
- vijačna priključitev

SOCKET TV-R END-LINE 1dB

- TV-R end-line
- frequency range 5÷862 MHz
- reduction: R-1.5dB, TV-1dB
- in accordance with EN 50083-1
- screw contact

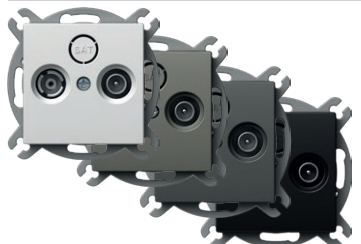

- KQ12PWXO
- KQ12TIXO
- KQ12ATXO
- KQ12BKXO

VTIČNICA TV-R PREHODNA 10dB

- TV-R prehodna
- frekvenčni pas 5÷862 MHz
- dušenje: R-10dB, TV-10dB, prehod-2dB
- ustreza EN 50083-1
- vijačna priključitev

SOCKET TV-R TROUGHPASS 10dB

- TV-R troughpass
- frequency range 5÷862 MHz
- reduction: R-10dB, TV-10dB, trough-2dB
- in accordance with EN 50083-1
- screw contacts

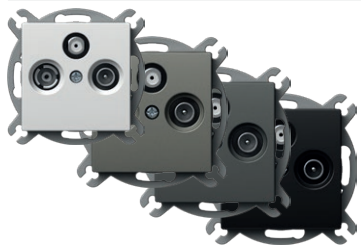

- KQ16PWXO
- KQ16TIXO
- KQ16ATXO
- KQ16BKXO

VTIČNICA SAT-TV-R KONČNA 3dB

- SAT-TV-R končna
- frekvenčni pas 5÷2400 MHz
- dušenje: R-1dB, TV-1.5dB, SAT-3dB
- ustreza EN 50083-1
- vijačna priključitev

SOCKET SAT-TV-R END-LINE 3dB

- SAT-TV-R end-line
- frequency range 5÷2400 MHz
- reduction: R-1dB, TV-1.5dB, SAT-3dB
- in accordance with EN 50083-1
- screw contacts



VTIČNICA AVDIO 2xRCA



- KQ22PWXO
- KQ22TIXO
- KQ22ATXO
- KQ22BKXO

- avdio 2xRCA
- pritrditev vodnikov s spajkanjem

SOCKET AUDIO 2xRCA

- audio 2xRCA
- soldering connection of cable



VTIČNICA AVDIO ZVOČNIŠKA



- KQ23PWXO
- KQ23TIXO
- KQ23ATXO
- KQ23BKXO

- avdio 2x Ø4mm
- za priklop zvočniškega vodnika, vtiča Ø4mm ali viličastega kabel čevlja
- pritrditev vodnikov zadaj s spajkanjem

SOCKET AUDIO LOUDSPEAKERS

- audio 2x Ø4mm
- to accommodate speaker wire, banana plug Ø4mm or spades
- soldering connection of cable at the back side



VTIČNICA TEL KS RJ11 6/4



- KQ36PWXO
- KQ36TIXO
- KQ36ATXO
- KQ36BKXO

- KS keystone pritrditveni standard
- RJ11 6/4
- ustreza IEC 60603-7

SOCKET TEL KS RJ11 6/4

- KS keystone fixing standard
- RJ11 6/4
- in accordance with IEC 60603-7



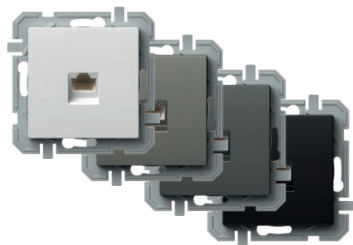

- KQ37PWXO
- KQ37TIXO
- KQ37ATXO
- KQ37BKXO

VTIČNICA CAT5e KS RJ45 8/8

- KS keystone pritrditveni standard
- CAT5e, RJ45 8/8
- ustreza IEC 60603-7

SOCKET CAT5e KS RJ45 8/8

- KS keystone fixing standard
- CAT5e, RJ45 8/8
- in accordance with IEC 60603-7



- KQ38PWXO
- KQ38TIXO
- KQ38ATXO
- KQ38BKXO

VTIČNICA TEL KS DVOJNA 2x RJ11 6/4

- KS keystone pritrditveni standard
- 2x RJ11, 6/4
- ustreza IEC 60603-7

SOCKET TEL KS DOUBLE 2x RJ11 6/4

- KS keystone fixing standard
- 2x RJ11, 6/4
- in accordance with IEC 60603-7

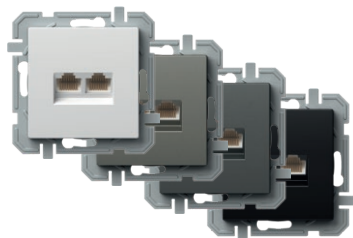

- KQ39PWXO
- KQ39TIXO
- KQ39ATXO
- KQ39BKXO

VTIČNICA CAT5e KS DVOJNA 2x RJ45 8/8

- KS keystone pritrditveni standard
- 2x CAT5e, RJ45 8/8
- ustreza IEC 60603-7

SOCKET CAT5e KS DOUBLE 2x RJ45 8/8

- KS keystone fixing standard
- 2x CAT5e, RJ45 8/8
- in accordance with IEC 60603-7



VTIČNICA TEL LT RJ11 6/4

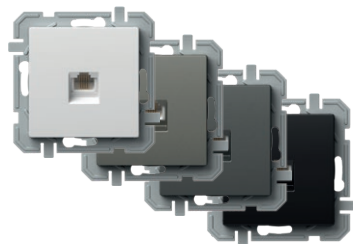

- KQ35PWXO
- KQ35TIXO
- KQ35ATXO
- KQ35BKXO

- TEL LT vijak
- vijačna pritrditveni vodnikov
- RJ11 6/4
- ustreza IEC 60603-7

SOCKET TEL LT RJ11 6/4

- TEL LT screw
- screw contacts
- RJ11 6/4
- in accordance with IEC 60603-7



VTIČNICA CAT6 KS RJ45 8/8



- KQ40PWXO
- KQ40TIXO
- KQ40ATXO
- KQ40BKXO

- KS keystone pritrditveni standard
- CAT6, RJ45 8/8
- ustreza IEC 60603-7

SOCKET CAT6 KS RJ45 8/8

- KS keystone fixing standard
- CAT6, RJ45 8/8
- in accordance with IEC 60603-7



VTIČNICA CAT6 KS DVOJNA 2x RJ45 8/8



- KQ41PWXO
- KQ41TIXO
- KQ41ATXO
- KQ41BKXO

- KS keystone pritrditveni standard
- 2xCAT, RJ45 8/8
- ustreza IEC 60603-7

SOCKET CAT6 KS DOUBLE 2x RJ45 8/8

- KS keystone fixing standard
- 2x CAT6, RJ45 8/8
- in accordance with IEC 60603-7

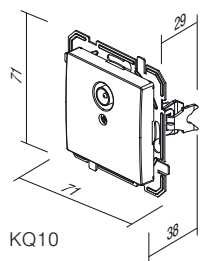

KQ10

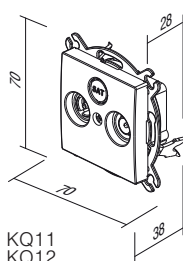

KQ11
KQ12

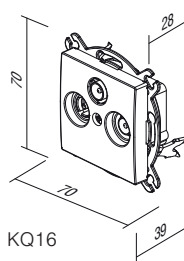

KQ16

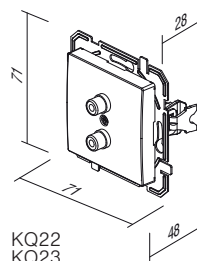

KQ22
KQ23

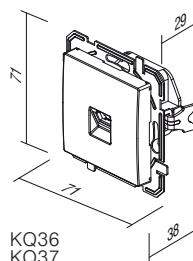

KQ36
KQ37
KQ35
KQ40

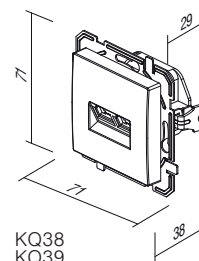

KQ38
KQ39
KQ41



EQ15 PW XO

tip type	naziv description	tehnični opis technical data	barva colour	opsijski opis 1 optional data 1
EQ15	ZATEMNILNIK ROTACIJSKI MEN DIMMER ROTATIVE 2WAY	RL 400W	<input type="checkbox"/> PW bela - sijaj polar white	XO brez okvirja without cover plate
EQ16	ZATEMNILNIK ROTACIJSKI MEN DIMMER ROTATIVE 2WAY	RLC 400W	<input type="checkbox"/> TI titan titanium	
EQ19	ZATEMNILNIK ROTACIJSKI MEN DIMMER ROTATIVE 2WAY	LED 100W	<input type="checkbox"/> AT antracit anthracite	
⋮	⋮	⋮	<input type="checkbox"/> BK črna black	

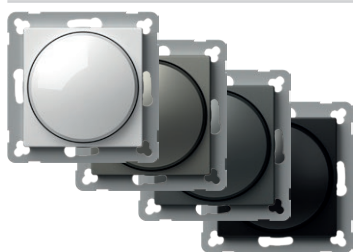

- EQ15PW
- EQ15TI
- EQ15AT
- EQ15BK

ZATEMNILNIK ROTACIJSKI MEN RL 400W

- rotacijski z menjalnim stikala
- breme RL, 40W - 400W
- možna vezava z menjalnim stikalom
- vezava več zatemnilnikov ni dovoljena
- ustreza EN 60669-1 in EN 60669-2-1
- brezvijačna pritrditev vodnikov 1.5mm²
- napajanje 230V~ 50Hz
- zamenljiva varovalka vključena

DIMMER ROTATIVE 2WAY RL 400W

- rotation control with 2-way switch
- load RL, 40W - 400W
- 2-way switch combination is possible
- more dimmers combination is not allowed
- in accordance with EN 60669-1 and EN 60669-2-1
- plug-in contacts 1.5mm²
- supply 230V~ 50Hz
- replaceable fuse included



ZATEMNILNIK ROTACIJSKI MEN RLC 400W



- EQ16PWXO
- EQ16TIXO
- EQ16ATXO
- EQ16BKXO

- rotacijski z menjalnim stikalom
- breme RLC, 20W - 400W
- možna vezava z menjalnim stikalom
- vezava več zatemnilnikov ni dovoljena
- ustreza EN 60669-1 in EN 60669-2-1
- brezvijačna pritrditev vodnikov 1.5mm²
- napajanje 230V~ 50Hz
- elektronska varovalka



DIMMER ROTATIVE 2WAY RLC 400W

- rotation control with 2-way switch
- load RLC, 20W - 400W
- 2-way switch combination is possible
- more dimmers combination is not allowed
- in accordance with EN 60669-1 and EN 60669-2-1
- plug-in contacts 1.5mm²
- supply 230V~ 50Hz
- electronic fuse

ZATEMNILNIK ROTACIJSKI MEN LED 100W



- EQ19PWXO
- EQ19TIXO
- EQ19ATXO
- EQ19BKXO

- rotacijski z menjalnim stikalom
- breme: LED, 0-100W (max. 10 LED sijalk) GLS, 10-250W
- možna vezava z menjalnim stikalom
- vezava več zatemnilnikov ni dovoljena
- ustreza EN 60669-1 in EN 60669-2-1
- brezvijačna pritrditev vodnikov 1,5 mm²
- napajanje 230V~ 50 Hz
- zamenljiva varovalka vključena



DIMMER ROTATIVE 2WAY LED 100W

- rotation control with 2-way switch
- load: LED, 0-100W (max. 10 LEDs) GLS, 10-250W
- 2-way switch combination is possible
- more dimmers combination is not allowed
- in accordance with EN 60669-1 and EN 60669-2-1
- plug-in contacts 1.5mm²
- supply 230V~ 50Hz
- replaceable fuse included

EQ15, EQ16, EQ19

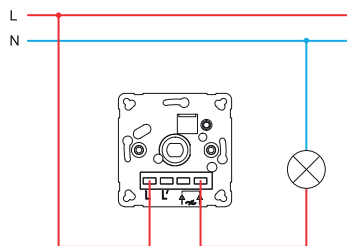

EQ15, EQ16, EQ19

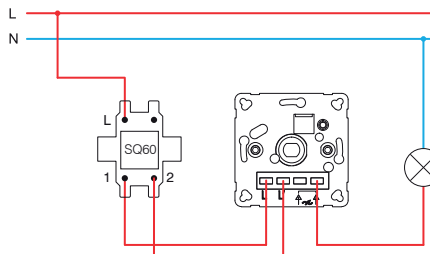

EQ15, EQ16, EQ19

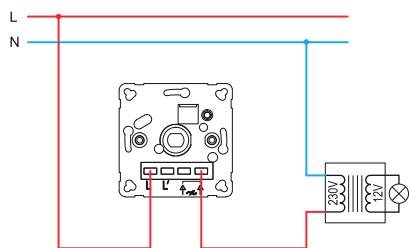

EQ15, EQ16, EQ19

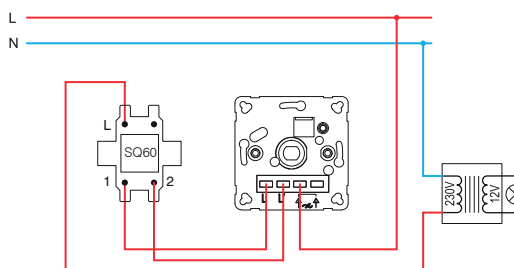

EQ16, EQ19

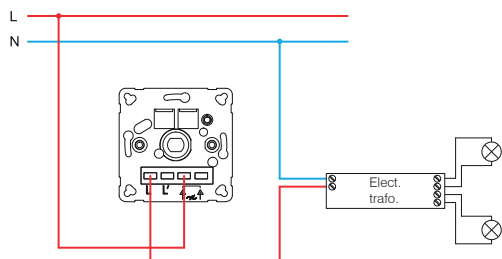

EQ16, EQ19

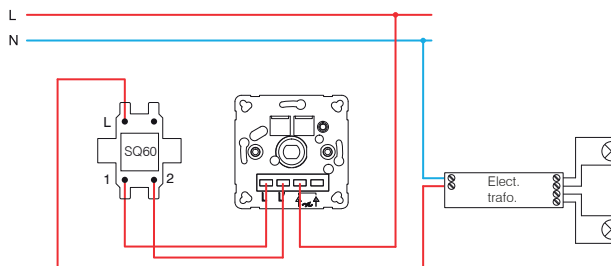

EQ15 (40÷400W)

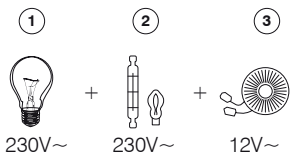

- 1 - žarnica z žarilno nitko / incandescent lamp
- 2 - halogenska žarnica / halogen lamp

EQ16 (20÷400W)

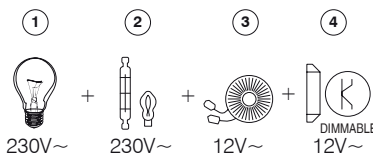

- 3 - klasični transformator / classical transformer
- 4 - zatemnilni el. transformator / dimmable electronic transformer

EQ19 (GLS 10÷250W ; LED 0÷100W)

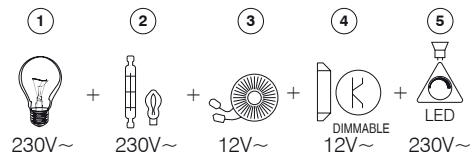

- 5 - zatemnilna LED sijalka / dimmable LED lamp



- EQ32PWXO
- EQ32TIXO
- EQ32ATXO
- EQ32BKXO

IR STIKALO 5A 230V~

- IR infrardeče stikalo
- napajanje: 230V~ ±10 % 50Hz
- Rele :5A/250V~ (zero crossing)
- stopnja varnosti: IP40
- presek žic pri stičniku: 0,75 - 2,5 mm²
- kot zaznavanja: do 110° pri 20°C
- območje zaznavanja: približno 8 m pri 20°C
- nastavljivost časovnega trajanja: od približno 5 s do 12 min
- nastavljivost osvetlitve: od približno 5 do 200 LUX
- temperatura delovanja: od 0°C do +40°C
- ni primeren za vgradnjo v doze, globine 45 mm
- samo za notranjo uporabo

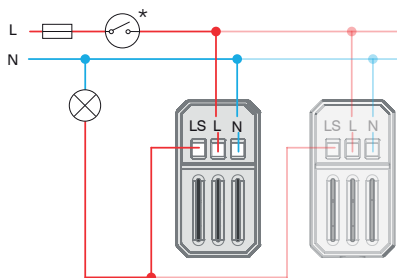

IR SWITCH 5A 230V~

- IR infrared switch
- supply voltage: 230V~ ±10 % 50Hz
- Relay :5A/250V~ (zero crossing)
- protection rating: IP40
- cross-section of wires at the contact terminal: 0.75 - 2.5 mm²
- detection angle: up to 110° at 20°C
- detection area: approx. 8 m at 20°C
- adjustability of duration: from approx. 5 s to 12 min
- adjustability of brightness: from approx. 5 to 200 LUX
- operating temperature: from 0°C to +40°C
- not suitable for installation in 45 mm deep boxes
- only for indoor usage

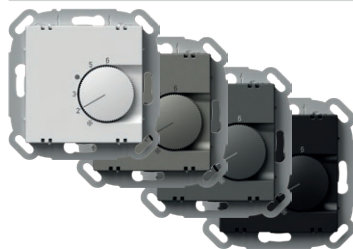

- EQ35PWXO
- EQ35TIXO
- EQ35ATXO
- EQ35BKXO

TERMOSTAT OGREVANJE 10A 230V~

- način delovanja: ogrevanje
- napajanje: 230 V~, 50 Hz
- izhod: 4 A (max. 10 A), 230 V~, 50 Hz
- izhodni priključek: NC (max. 10 aktuatorjev)
- območje regulacije: +5 °C do +30 °C
- histereza: 0,5 K
- zaščita: IP30
- vrsta tipala: bimetal
- vrsta električnega priključka: vzmetni kontakti
- vrsta vodnikov: 0,75 - 1,5mm² (mehko-žilni) ali 1,0 - 2,5 mm² (trdo-žilni)

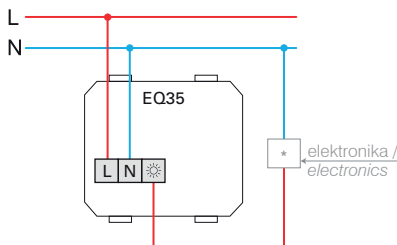

THERMOSTAT HEATING 10A 230V~

- operation mode: heating
- power supply: 230 V~, 50 Hz
- output: 4 A (max. 10 A), 230 V~, 50 Hz
- switching contact: NC (max. 10 actuators)
- regulation range: +5 °C to +30 °C
- hysteresis: 0,5 K
- protection: IP30
- sensor type: bimetal
- type of electrical connection: spring-loaded contacts
- type of conductors: 0,75 - 1,5mm² (flexible-stranded core) or 1,0 - 2,5 mm² (solid core)

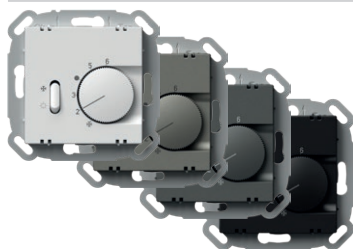

- EQ36PWXO
- EQ36TIXO
- EQ36ATXO
- EQ36BKXO

TERMOSTAT OGREVANJE / HLAJENJE 5A 230V~

- način delovanja: ogrevanje / hlajenje
- napajanje: 230 V~, 50 Hz
- izhod: 2 A (max. 5 A), 230 V~, 50 Hz
- izhodni priključek: preklopno stikalo (max. 5 aktuatorjev)
- območje regulacije: +5 °C do +30 °C
- histereza: 0,5 K
- zaščita: IP30
- vrsta tipala: bimetal
- vrsta električnega priključka: vzmetni kontakti
- vrsta vodnikov: 0,75 – 1,5mm² (mehko-žilni) ali 1,0 – 2,5 mm² (trdo-žilni)

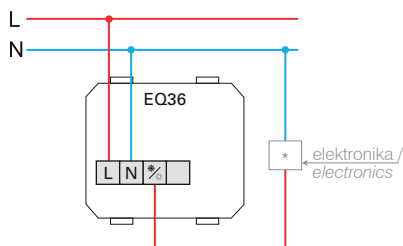

THERMOSTAT HEATING / COOLING 5A 230V~

- operation mode: heating / cooling
- power supply: 230 V~, 50 Hz
- output: 2 A (max. 5 A), 230 V~, 50 Hz
- switching contact: changeover switch (toggler, max. 5 actuators)
- regulation range: +5 °C to +30 °C
- hysteresis: 0,5 K
- protection: IP30
- sensor type: bimetal
- type of electrical connection: spring-loaded contacts
- type of conductors: 0,75 – 1,5mm² (flexible-stranded core) or 1,0 – 2,5 mm² (solid core)

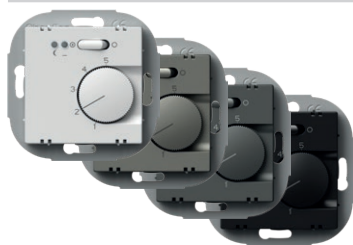

- EQ37PWXO
- EQ37TIXO
- EQ37ATXO
- EQ37BKXO

TERMOSTAT TALNO OGREVANJE 16A 230V~

- način delovanja: talno ogrevanje
- napajanje: 230 V~, 50 Hz
- izhod: 2 A (max. 16 A), 230 V~, 50 Hz
- območje regulacije: +10 °C do +50 °C
- histereza: 1 K
- zaščita: IP30
- vrsta tipala: NTC v skladu z DIN EN 60730-2-1
- indikatorji: rdeča LED za ogrevanje in zelena LED za nočni zmanjšani način
- vrsta električnega priključka: vijaki kontakti
- vrsta vodnikov: 0,5 – 2,5 mm²

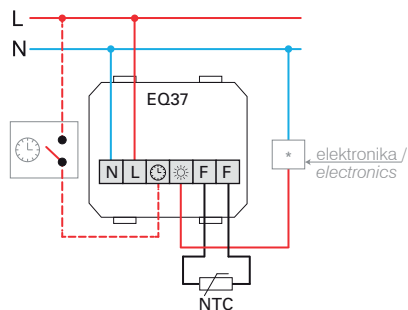

THERMOSTAT FLOOR HEATING 16A 230V~

- operation mode: floor heating
- power supply: 230 V~, 50 Hz
- output: 2 A (max. 16 A), 230 V~, 50 Hz
- regulation range: +10 °C to +50 °C
- hysteresis: 1 K
- protection: IP30
- sensor type: NTC in compliance with DIN EN 60730-2-1
- indicators: Red LED for heating and green LED for night decrease mode
- type of electrical connection: Screw contacts
- type of conductors: 0,5 – 2,5mm²

POLNILNIK USB 5V 3,0A



- EQ68PWXO
- EQ68TIXO
- EQ68ATXO
- EQ68BKXO

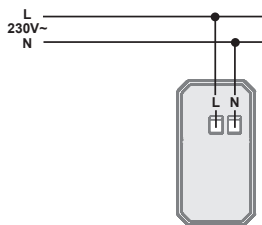

elektronika /
electronics

- za polnjenje elektronskih naprav prek standardnega USB priključka (kompatibilno tudi z Apple napravami)
- napajanje: 100-230 V~ 50/60 Hz
- poraba med delovanjem: 300 mA pri 100 V~ /150 mA pri 230 V~
- poraba v mirovanju: 30 mW pri 230 V~
- izhodna napetost: 5 VDC ($\pm 5\%$) SELV
- nihanje izhodne napetosti: 150 mV
- nominalni izhodni tok: 3,0 A ($\pm 10\%$)
- tip konektorja: USB A / USB C
- učinkovitost: maksimalno 77 %
- temperatura delovanja: 0 °C/+ 45 °C (notranja uporaba)
- IP zaščitni razred: IP20, samo za notranjo uporabo
- varnostni razred naprave II
- prenapetostna zaščita (EN 62109): razred III
- vijačna pritrditev vodnikov max. 2.5 mm²
- naprava z odmikom kontaktov min. 3 mm
- ustreza standardu EN 60950-1 in direktivam EMC in LVD

USB POWER SUPPLY UNIT 5V 3.0A

- for charging electronic devices via a standard USB port (also compatible with Apple devices)
- power supply: 100-230V~ 50/60Hz
- power consumption: 300mA at 100V~/150mA at 230V~
- standby power consumption: 30mW at 230V~
- nominal output voltage: 5 VCD ($\pm 5\%$) SELV
- output ripple voltage: 150mV
- nominal output current: 3.0 A ($\pm 10\%$)
- connector type: USB A / USB C
- efficiency: maximum of 77%
- operating temperature: 0°C/+45°C (indoor use)
- IP protection class: IP20, indoor use only
- class device II
- overvoltage category (EN 62109): Class III
- screw contacts: max. 2.5 mm²
- device with a contact gap of at least 3mm
- in accordance with the EN 60950-1 and LVD & EMC directives

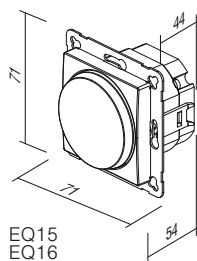

EQ15
EQ16
EQ19

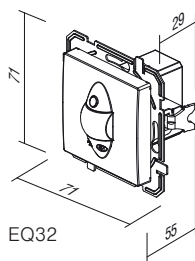

EQ32

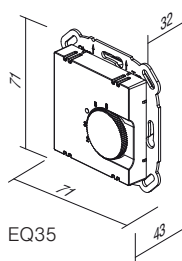

EQ35

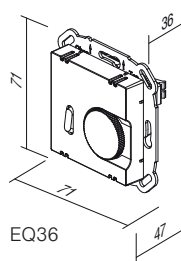

EQ36

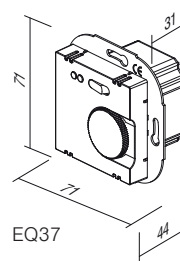

EQ37

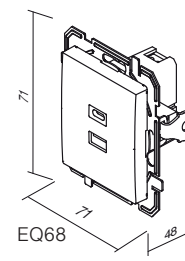

EQ68

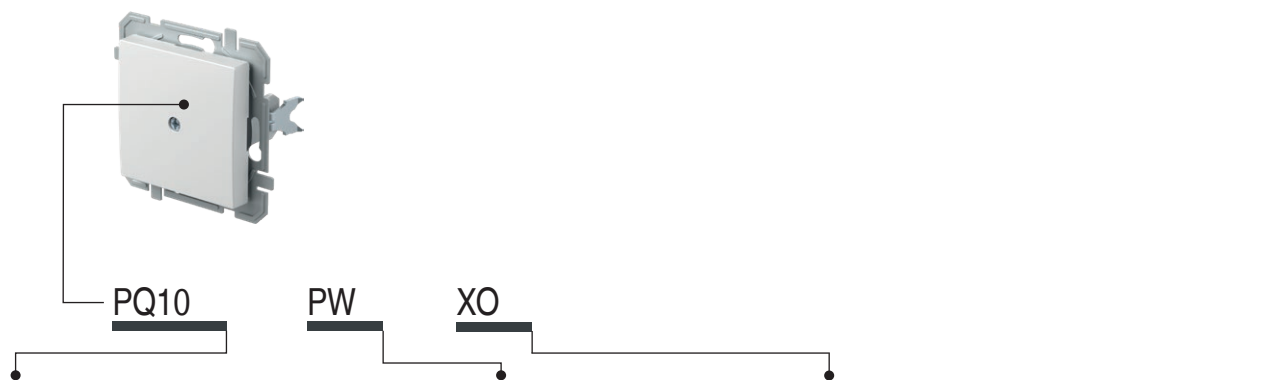

tip type	naziv description	barva colour	opsijski opis 1 optional data 1
PQ10	POLNILO BLANK	□ PW bela - sijaj polar white	XO brez okvirja without cover plate
PQ30	POKROV TAE/TDO COVER TAE/TDO	■ TI titan titanium ■ AT antracit anthracite ■ BK črna black	

POLNILO



- PQ10PWXO
- PQ10TIXO
- PQ10ATXO
- PQ10BKXO

- za pokrivanje praznih odprtin
BLANK
- for filling up empty spaces



POKROV TAE/TDO

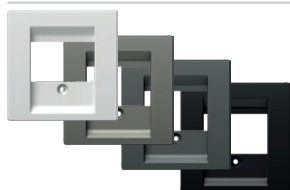

- PQ30PW
- PQ30TI
- PQ30AT
- PQ30BK

- TAE ali TDO pokrov z vijakom
COVER TAE/TDO
- TAE or TDO cover with screw

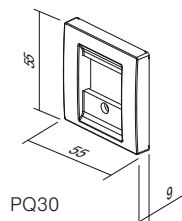
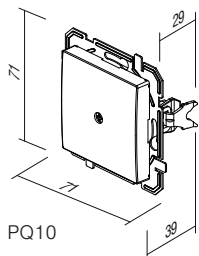

OKVIRJI BOLD OQ

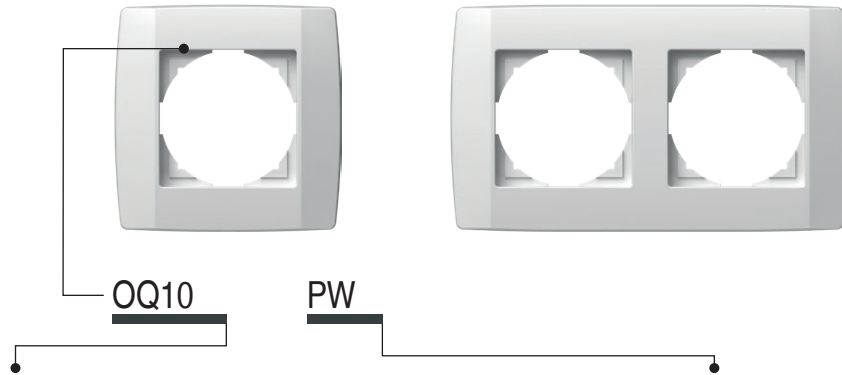

tip type	naziv description	barva colour
OQ10	OKVIR BOLD 1 COVER PLATE BOLD 1	PW bela - sijaj polar white
OQ20	OKVIR BOLD 2 COVER PLATE BOLD 2	TI titan titanium
OQ30	OKVIR BOLD 3 COVER PLATE BOLD 3	AT antracit anthracite
:	:	BK črna black
:	:	



	OQ10PW
	OQ10TI
	OQ10AT
	OQ10BK

OKVIR BOLD 1

- dekorativni 1-mestni okvir
- ustreza EN 60669-1

COVER PLATE BOLD 1

- decorative cover plate 1-gang
- in accordance with EN 60669-1

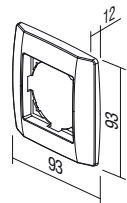

	OQ20PW
	OQ20TI
	OQ20AT
	OQ20BK

OKVIR BOLD 2

- dekorativni 2-mestni okvir
- ustreza EN 60669-1

COVER PLATE BOLD 2

- decorative cover plate 2-gang
- in accordance with EN 60669-1

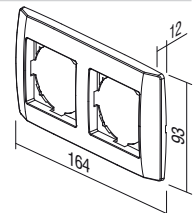



- QQ30PW
- QQ30TI
- QQ30AT
- QQ30BK

OKVIR BOLD 3

- dekorativni 3-mestni okvir
- ustreza EN 60669-1

COVER PLATE BOLD 3

- decorative cover plate 3-gang
- in accordance with EN 60669-1

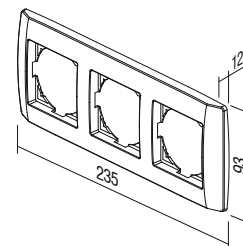

- QQ40PW
- QQ40TI
- QQ40AT
- QQ40BK

OKVIR BOLD 4

- dekorativni 4-mestni okvir
- ustreza EN 60669-1

COVER PLATE BOLD 4

- decorative cover plate 4-gang
- in accordance with EN 60669-1

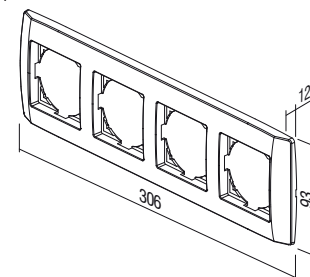

- QQ50PW
- QQ50TI
- QQ50AT
- QQ50BK

OKVIR BOLD 5

- dekorativni 5-mestni okvir
- ustreza EN 60669-1



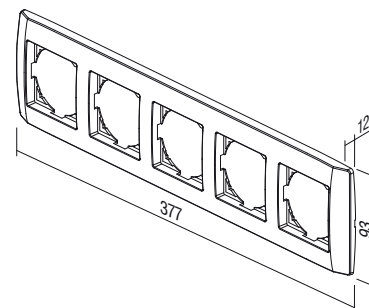

COVER PLATE BOLD 5

- decorative cover plate 5-gang
- in accordance with EN 60669-1

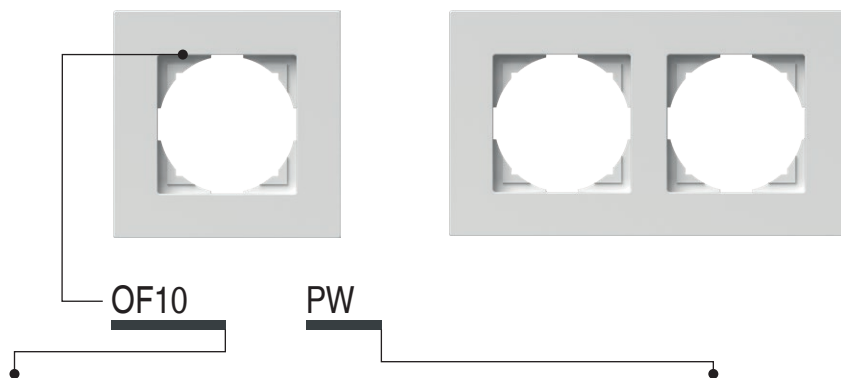





OKVIRJI FLAT OF



tip type	naziv description	barva colour
OF10	OKVIR FLAT 1 COVER PLATE FLAT 1	 PW bela - sijaj polar white
OF20	OKVIR FLAT 2 COVER PLATE FLAT 2	 TI titan titanium
OF30	OKVIR FLAT 3 COVER PLATE FLAT 3	 AT antracit anthracite
.	.	 BK črna black
.	.	



	OF10PW
	OF10TI
	OF10AT
	OF10BK





OKVIR FLAT 1

- dekorativni 1-mestni okvir
- ustreza EN 60669-1

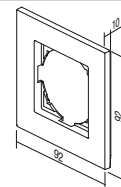
COVER PLATE FLAT 1

- decorative cover plate 1-gang
- in accordance with EN 60669-1



	OF20PW
	OF20TI
	OF20AT
	OF20BK

OKVIR FLAT 2

- dekorativni 2-mestni okvir
- ustreza EN 60669-1

COVER PLATE FLAT 2

- decorative cover plate 2-gang
- in accordance with EN 60669-1

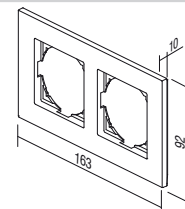

OKVIR FLAT 3



- OF30PW
- OF30TI
- OF30AT
- OF30BK

- dekorativni 3-mestni okvir
- ustreza EN 60669-1

COVER PLATE FLAT 3

- decorative cover plate 3-gang
- in accordance with EN 60669-1

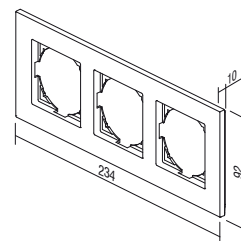

OKVIR FLAT 4



- OF40PW
- OF40TI
- OF40AT
- OF40BK

- dekorativni 4-mestni okvir
- ustreza EN 60669-1

COVER PLATE FLAT 4

- decorative cover plate 4-gang
- in accordance with EN 60669-1

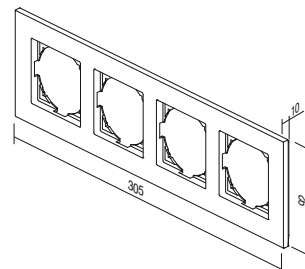

OKVIR FLAT 5



- OF50PW
- OF50TI
- OF50AT
- OF50BK

- dekorativni 5-mestni okvir
- ustreza EN 60669-1

COVER PLATE FLAT 5

- decorative cover plate 5-gang
- in accordance with EN 60669-1

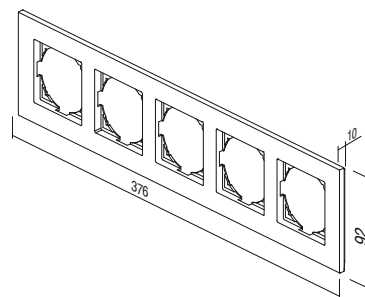

O K V I R J I P R I M E O R

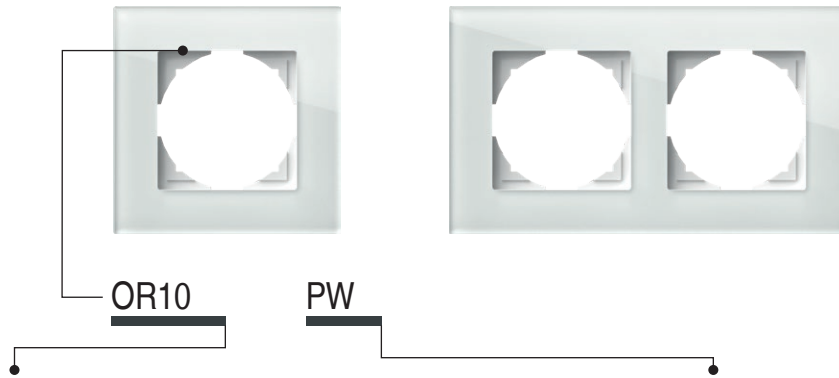

tip type	naziv description	barva colour
OR10	OKVIR PRIME 1 COVER PLATE PRIME 1	GL bela glass light
OR20	OKVIR PRIME 2 COVER PLATE PRIME 2	GD črna glass dark
OR30	OKVIR PRIME 3 COVER PLATE PRIME 3	
⋮	⋮	
⋮	⋮	

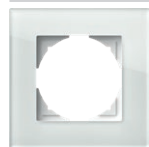

OR10GL
 OR10GD

OKVIR PRIME 1

- dekorativni 1-mestni okvir
- ustreza EN 60669-1

COVER PLATE PRIME 1

- decorative cover plate 1-gang
- in accordance with EN 60669-1

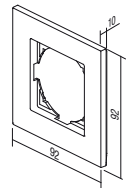

OR20GL
 OR20GD

OKVIR PRIME 2

- dekorativni 2-mestni okvir
- ustreza EN 60669-1

COVER PLATE PRIME 2

- decorative cover plate 2-gang
- in accordance with EN 60669-1

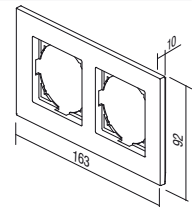

OKVIR PRIME 3



OR30GL
OR30GD

- dekorativni 3-mestni okvir
- ustreza EN 60669-1

COVER PLATE PRIME 3

- decorative cover plate 3-gang
- in accordance with EN 60669-1

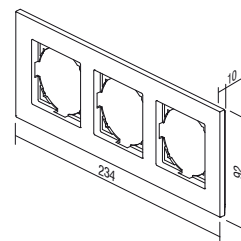

OKVIR PRIME 4



OR40GL
OR40GD

- dekorativni 4-mestni okvir
- ustreza EN 60669-1

COVER PLATE PRIME 4

- decorative cover plate 4-gang
- in accordance with EN 60669-1

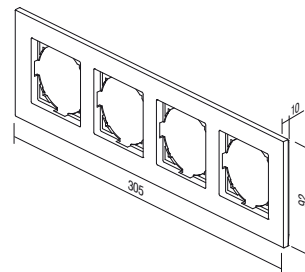

TEM
WWW.TEM.SI
SLO 2024

TEM Čatež d.o.o.
Čatež 13, 8212 Velika Loka
Slovenija
e: info@tem.si
w: www.tem.si
t: +386 (0)7 348 99 00

